

**SANITARIOS  
LAVABOS**

**SANITARIOS-LAVABOS  
2017**



# Legend



# legend

# legend

LEGEND.WCTB

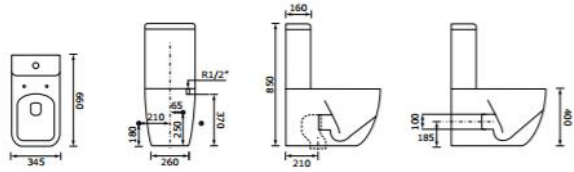

LEGEND.WCS

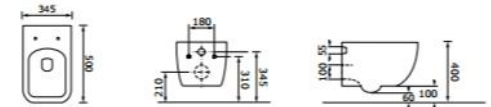

LEGEND.BD



LEGEND.BDS

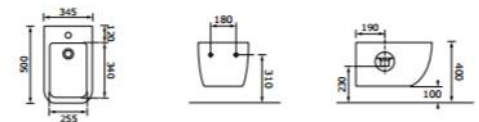

LEGEND.LP55

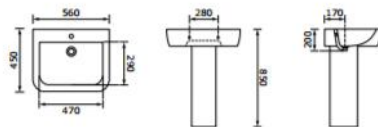

**arco**





arco

arco

ARCO.WCTB

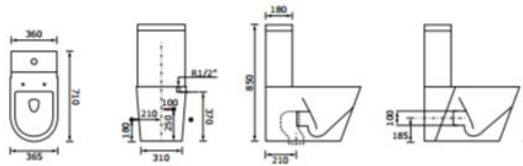

ARCO.LP60

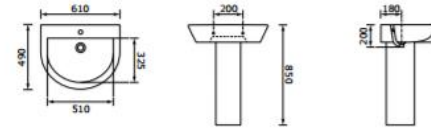

ARCO.WCTA

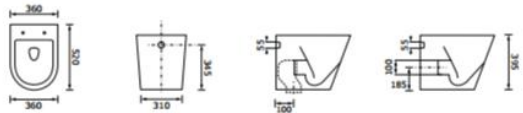

ARCO.WCS

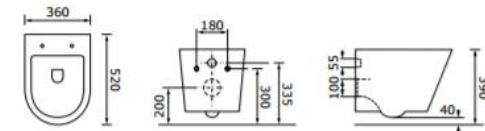

ARCO.BD

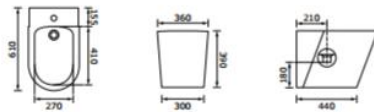

**brise**



# brise

BRISE.WCTB

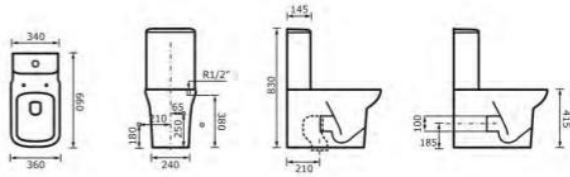

BRISE.WCS

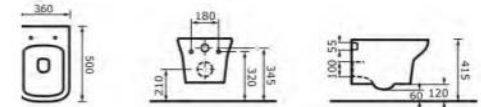

BRISE.BD



BRISE.BDS

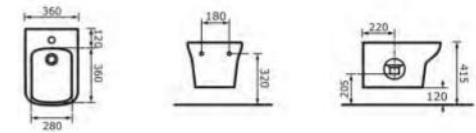

BRISE.LP55

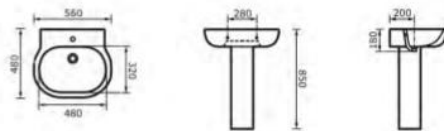

# cutie





cutie

# SANITARIO PACK MARK

CUTIE.WCTB

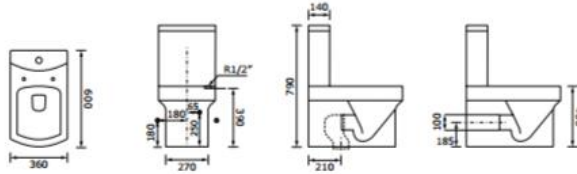

CUTIE.BD

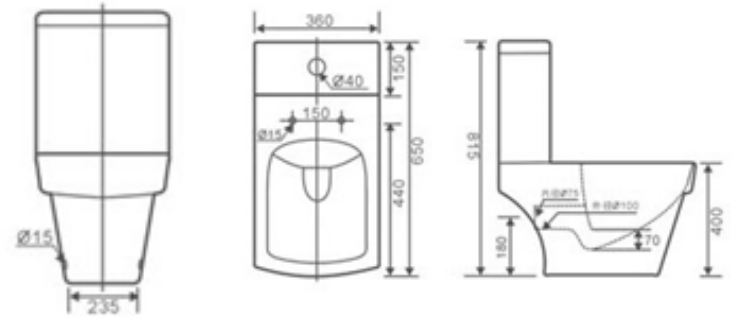
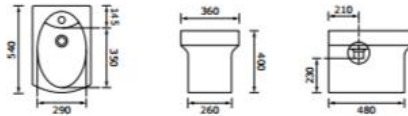

CUTIE.LP55

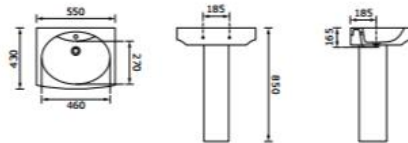

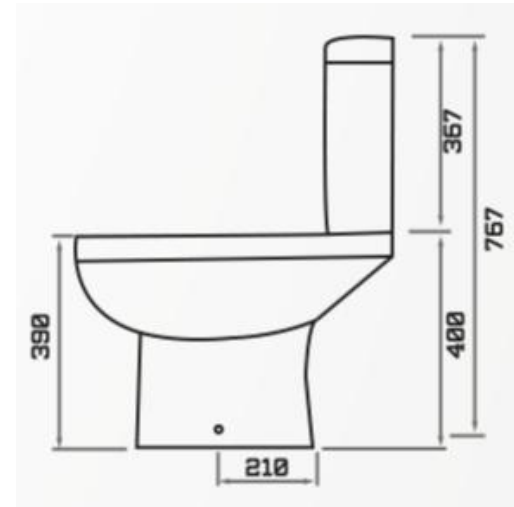
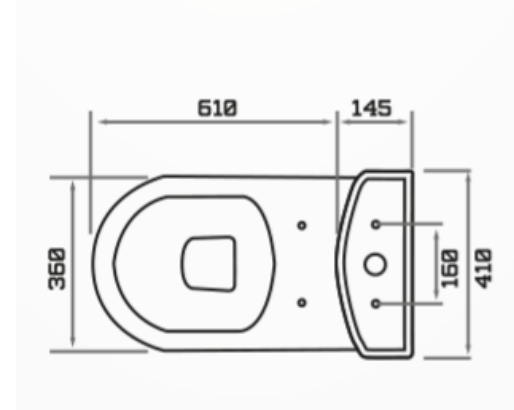

**SANITARIO PACK**

**OCEANIC**

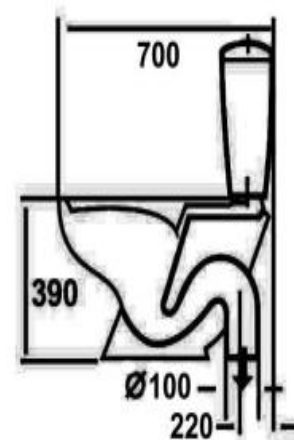
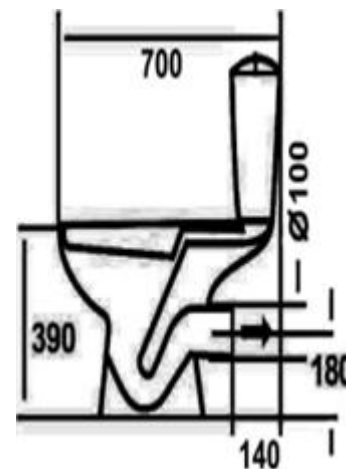

*Ever*

**CONJUNTOS**

# OCEANIC / TRIPOLI

# LAVABO con PEDESTAL

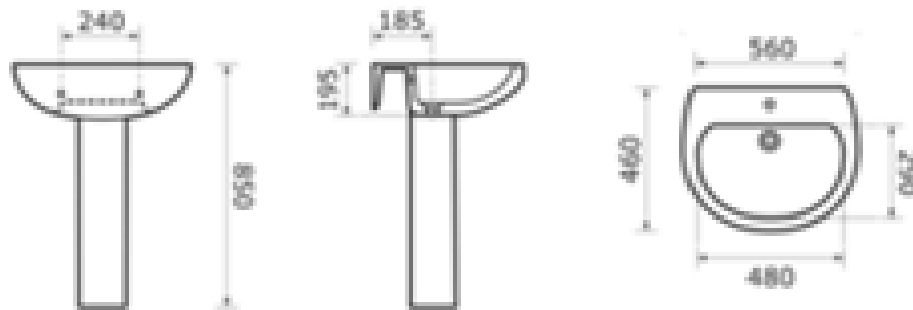

# OCEANIC / TRIPOLI

# BIDET

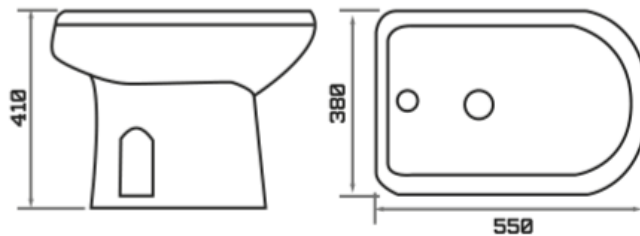

The logo for the brand 'Ever', featuring the word 'Ever' in a stylized, cursive font with a red underline.



**SANITARIO PACK SUSPENDIDO**

**SQUARE**



**CONJUNTOS**



LAVABOS SOBRE ENCIMERAS



**BOWL** 40\*40\*15 cm.



**CERES** 55\*48\*11 cm.



**SPA 43** 43\*43\*17 cm.



**DANAE** 41\*33\*14.5 cm.



**CIRCULAR** 49\*49\*13 cm.



**GEA** 63\*40\*10 cm.



**EVO** 41\*41\*14 cm.



**LAMP** 42\*42\*14 cm.



**JANO** 55\*35\*14 cm.



**VESTA** 47\*36\*13 cm.



**VULCANO** 44\*42\*15 cm.  
opción a pared.



**BOAT** 57.5\*38\*10 cm.  
opción a pared.



**HIDRA** 38\*38\*14 cm.



**CLIO** 45\*42\*10 cm.  
opción a pared



**DANA** 41.5\*41.5\*13 cm.



**MEDEA** 83\*44\*15cm.



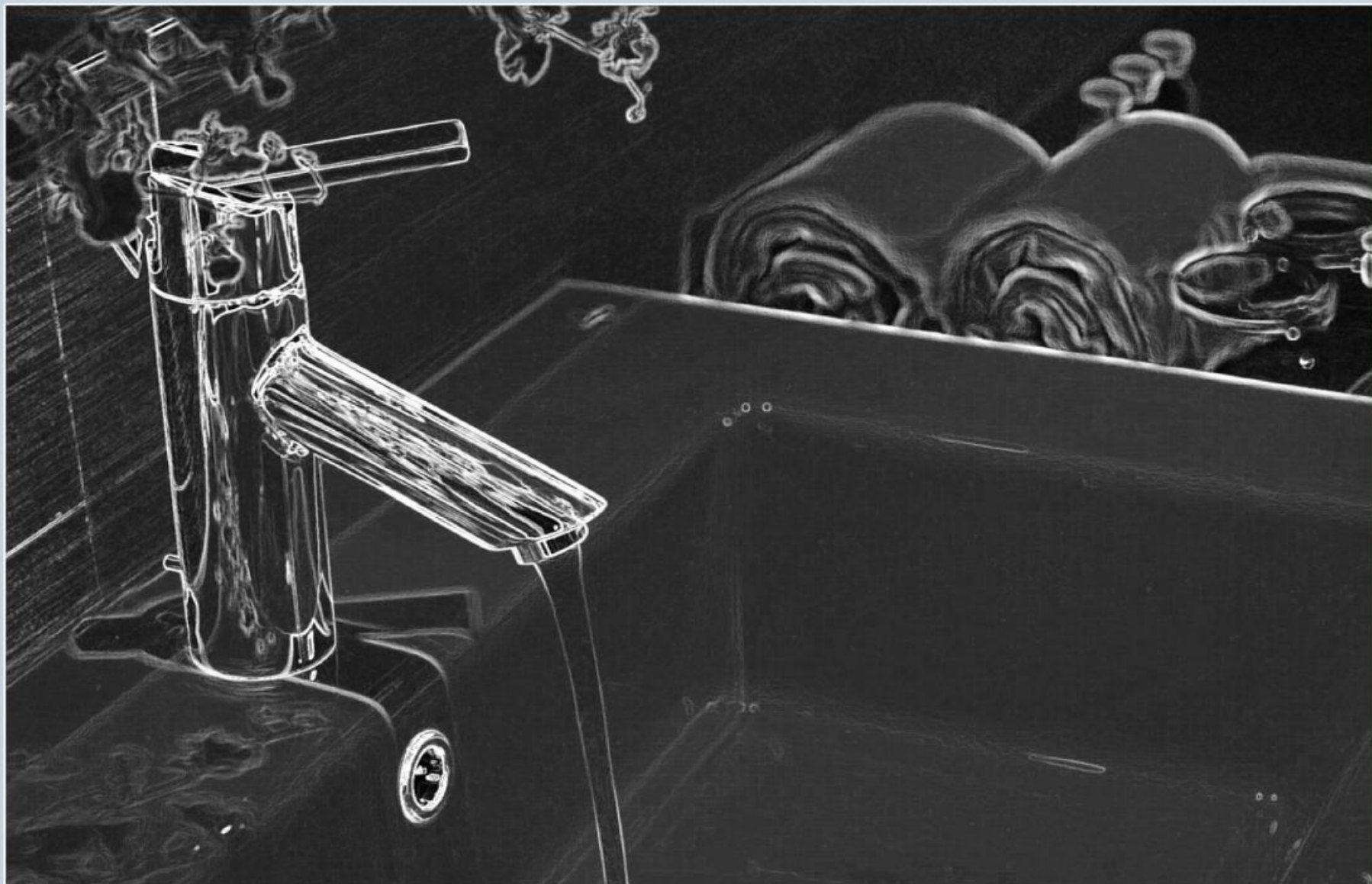

LAVABOS ENCIMERAS





### **SERIE EGEO**

**Fondo 46 cm.** frontal 2 cm.

61 / 71 / 76 / 81 / 91 / 91 izq / 101  
121 / 121 doble seno

**Fondo 39 cm.** frontal 2 cm.

61 / 71 / 76 / 81 / 91 / 101



### **SERIE ERIS**

**Fondo 46 cm.** frontal 2 cm.

61 / 71 / 81 / 91 / 101 / 121 /  
121 doble seno



### **SERIE EOLO**

**Fondo 46 cm.** frontal 2 cm.

61 / 71 / 76 / 81 / 91 / 101 / 121 /  
121 doble seno



### **SERIE ETRO**

**Fondo 46 cm.** frontal 2 cm.

61 / 71 / 81 / 91 / 101 cm.



LAVABOS DE ENCASTRE



**OPS** 55\*34\*16 cm.



**ATLAS** 60\*39\*19 cm.  
frontal delantero 4.5 cm.  
frontal lateral 7 cm.



**HERMES** 80\*45\*21 cm.  
Encastre lateral 43.5 cm.



**WISE 60** 60\*39\*17 cm.  
frontal 3.5 cm.



**PLANO** 51\*40\*17 cm.



**CEO** 53\*42\*17 cm.



**PALANTE** 50\*45\*14 cm.  
Encastre lateral 30 cm.



**CIRCLE** diam. 40 cm.  
encastre 38 cm.



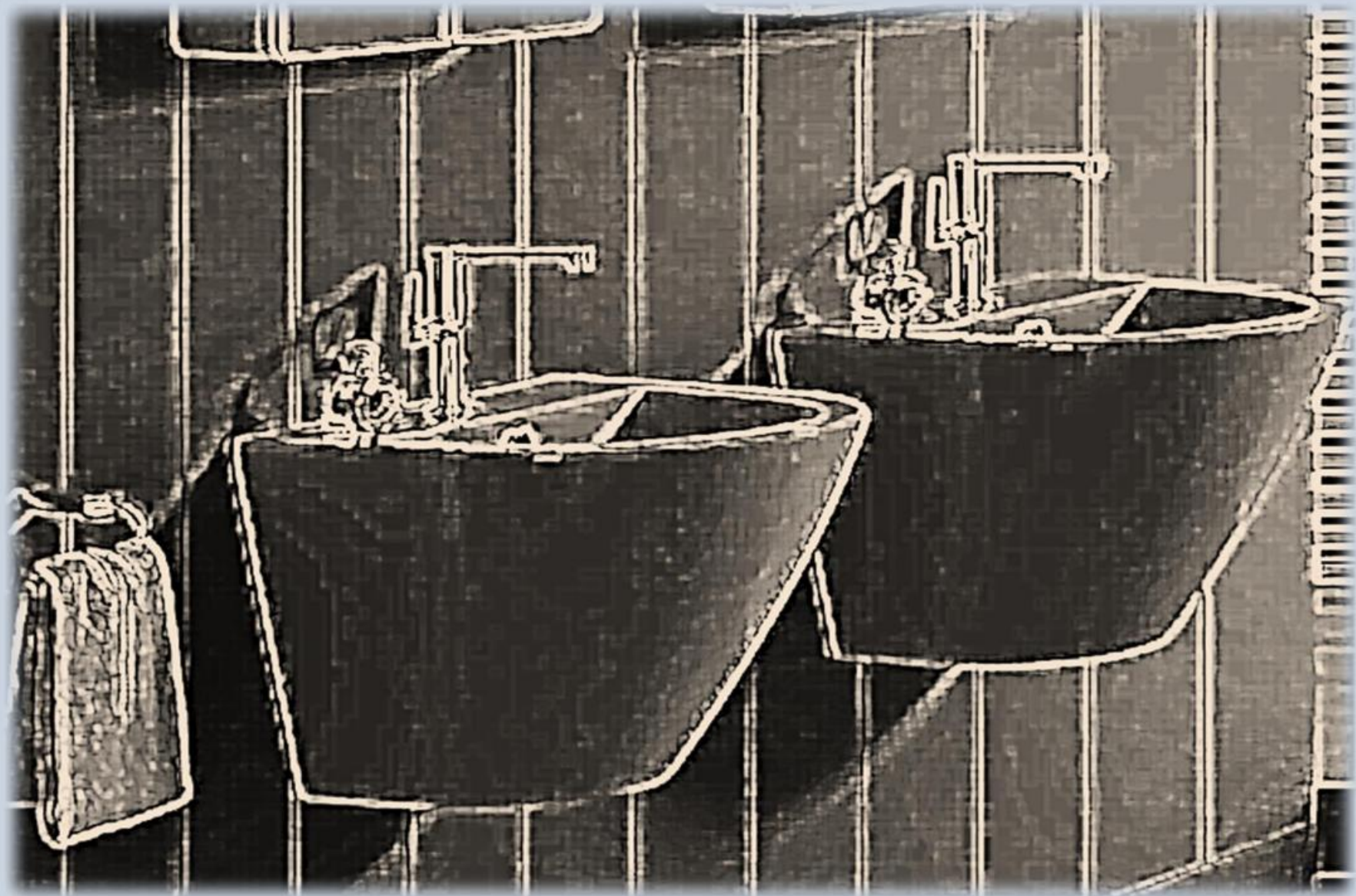

LAVABOS A PARED





**SUQUR** 37.5\*41\*40 cm.



**SILBANO** 50\*48\*41 cm.



LAVABO BAJO ENCIMERA



**OVAL** 50.5\*41.5\*22 cm.  
interior 43\*35.5 cm.



**BAREK** 53\*34.5\*17.5 cm.

# COLORES







**LAMP Plata** 42\*42\*14 cm.



**DANAE Oro** 41\*33\*14.5 cm.



**SPA 43 b/n** 43\*43\*17 cm.



**DANA Negro** 41.5\*41.5\*13 cm

**LAVABOS MATE**

LAVABOS MATE



**ROUND** 35\*35\*11.5 cm.



**SQUARE** 36\*36\*11.5 cm.

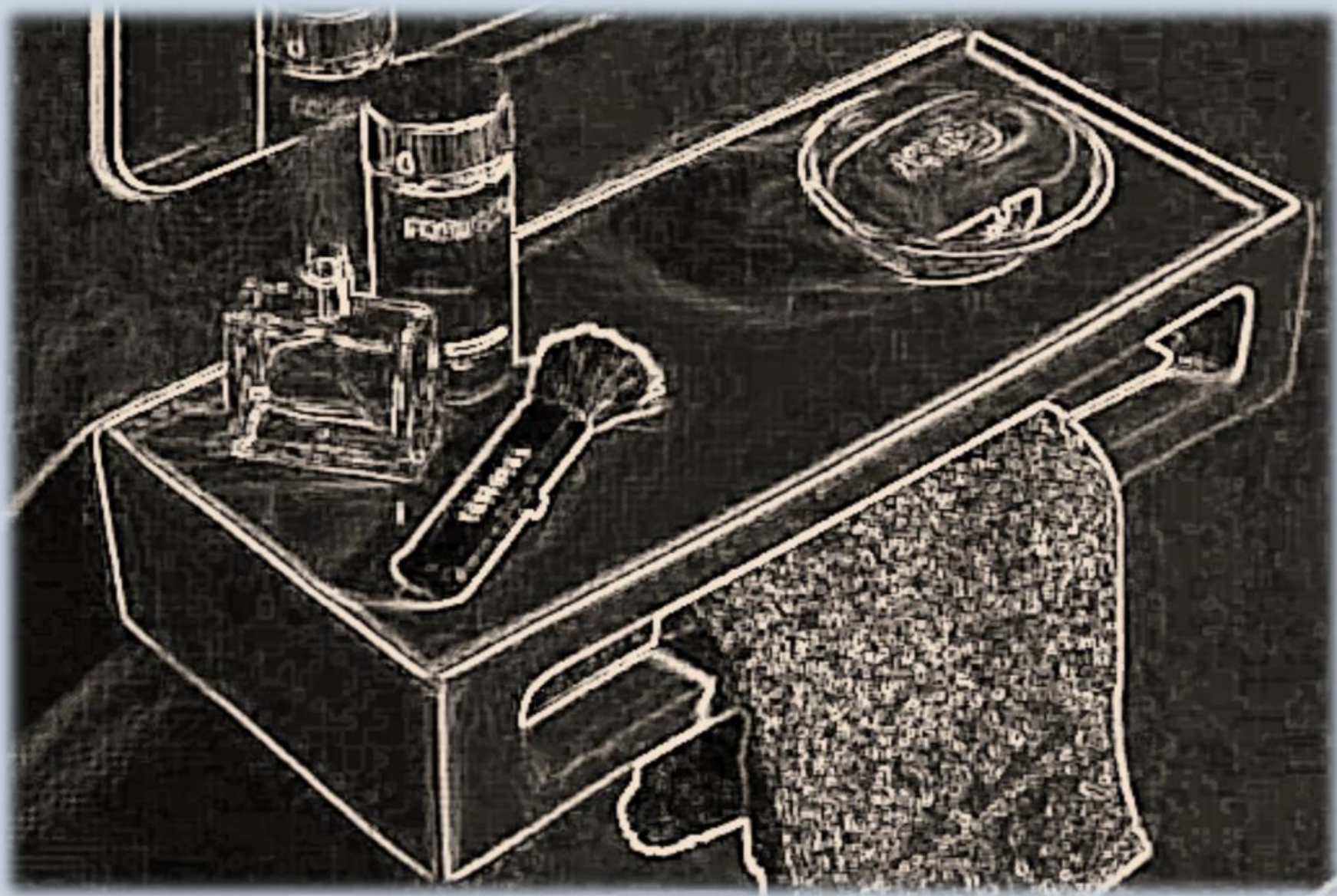

SOPORTES





**S-1** 20\*36\*10 cm.



**S-2** 20\*42\*10 cm.



**S-3** 20.5\*46.5\*10 cm.



**S-4** 41\*18\*10 cm.



**Colección 2014**



**Distribuidor:**

P.O.Box 93  
46910 Benetuser  
Valencia-Spain  
Telf.: +34 960 113 457  
Fax: +34 963 214 332  
[ever@evercomercial.es](mailto:ever@evercomercial.es)  
[www.evercomercial.es](http://www.evercomercial.es)